

SCHEMA TECNICA TECHNICAL FEATURES

Art. 114FE3009

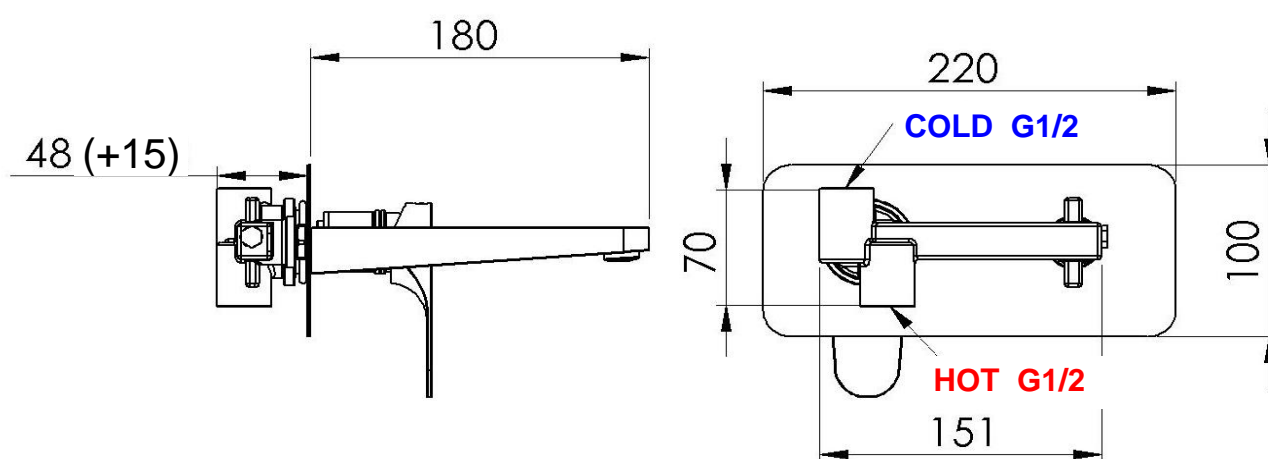

MATERIALI / MATERIALS

OTTONE CROMATO / CHROME PLATED BRASS

CROMATURA / CHROME PLATING

UNI EN 248