

SCHEDA TECNICA TECHNICAL FEATURES

Art. 2637/300

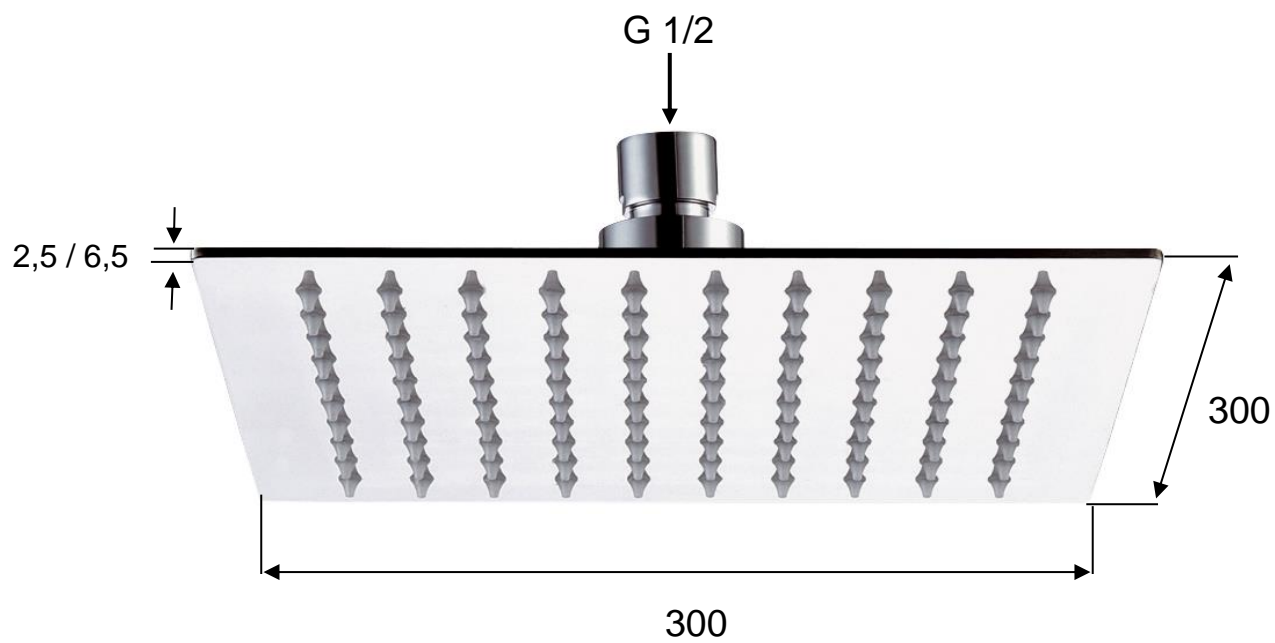

MATERIALI / MATERIALS

ACCIAIO INOX AISI 304 / AISI 304 STAINLESS STEEL

CROMATURA / CHROME PLATING

UNI EN 248