

# SCHEMA TECNICA TECHNICAL FEATURES

Art. 103D5009

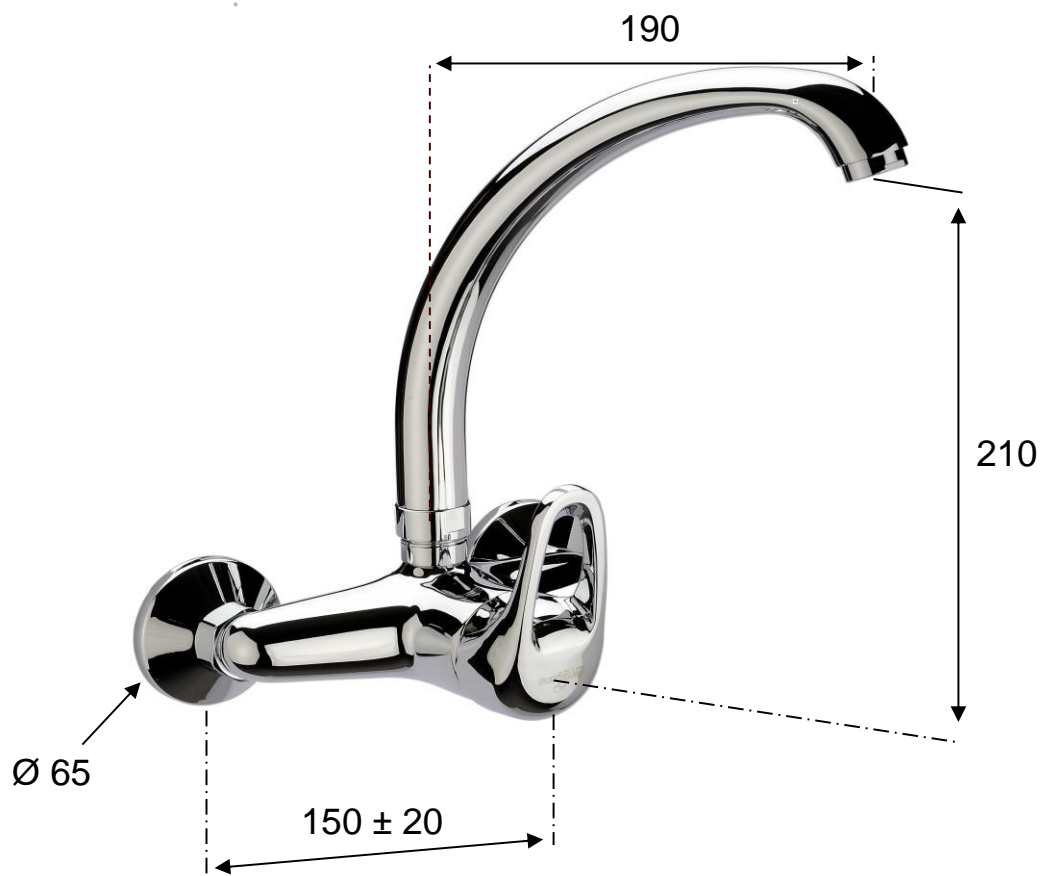

## MATERIALI / MATERIALS

OTTONE CROMATO / CHROME PLATED BRASS

## CROMATURA / CHROME PLATING

UNI EN 248