

SCHEDA TECNICA TECHNICAL FEATURES

Art. 112AB2015

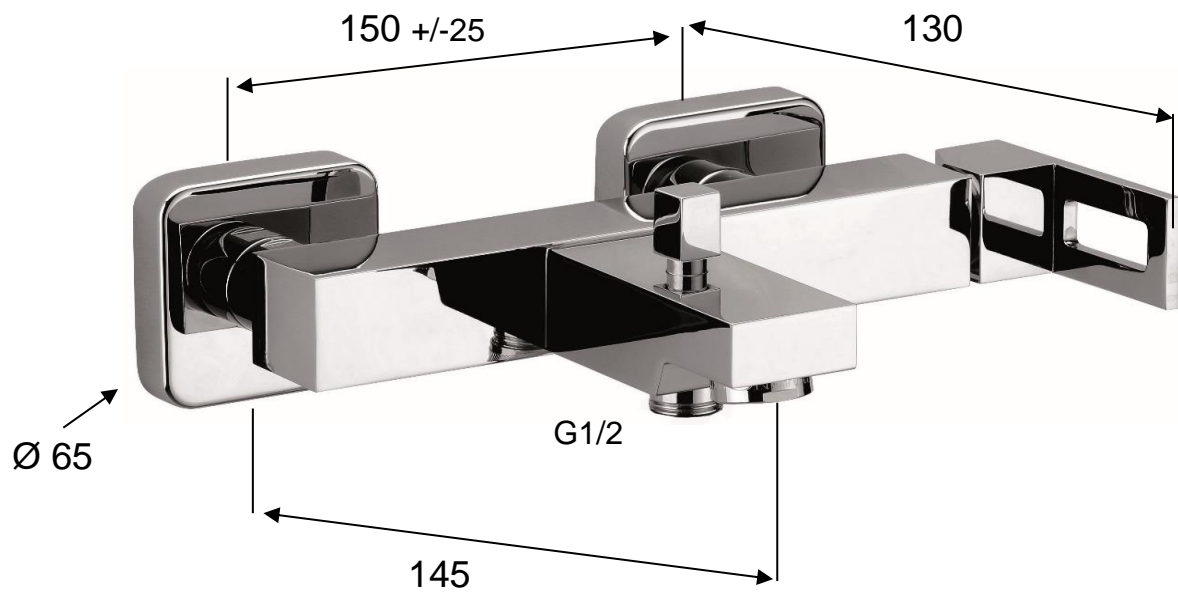

MATERIALI / MATERIALS

OTTONE CROMATO / CHROME PLATED BRASS

CROMATURA / CHROME PLATING

UNI EN 248