

# SCHEDA TECNICA TECHNICAL FEATURES

Art. 116DE2015

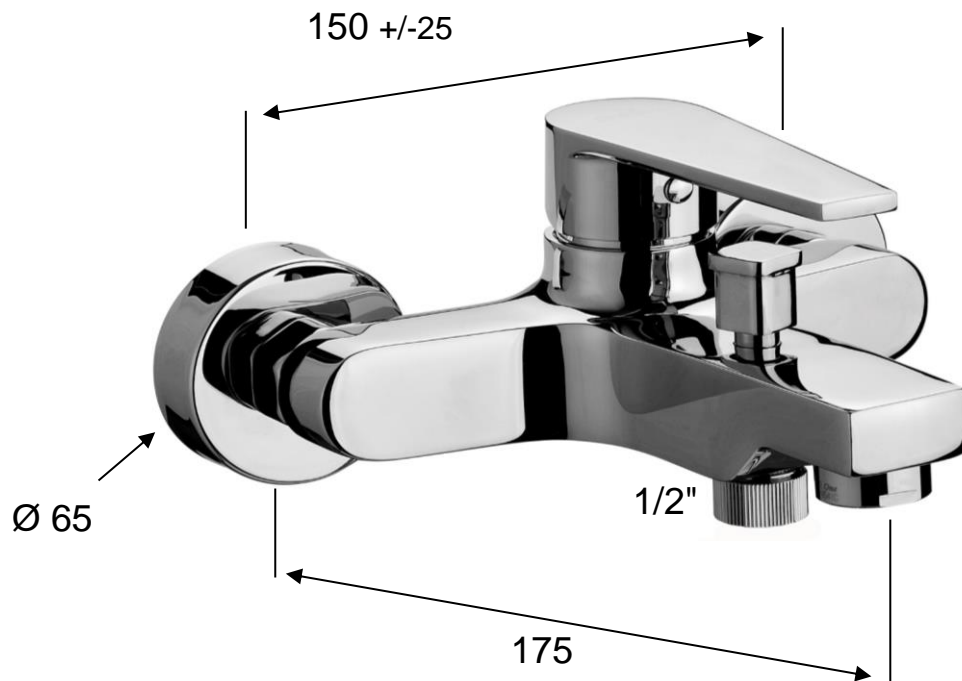

## **MATERIALI / MATERIALS**

OTTONE CROMATO / CHROME PLATED BRASS

## **CROMATURA / CHROME PLATING**

UNI EN 248