

SCHEDA TECNICA TECHNICAL FEATURES

Art. 240X2000

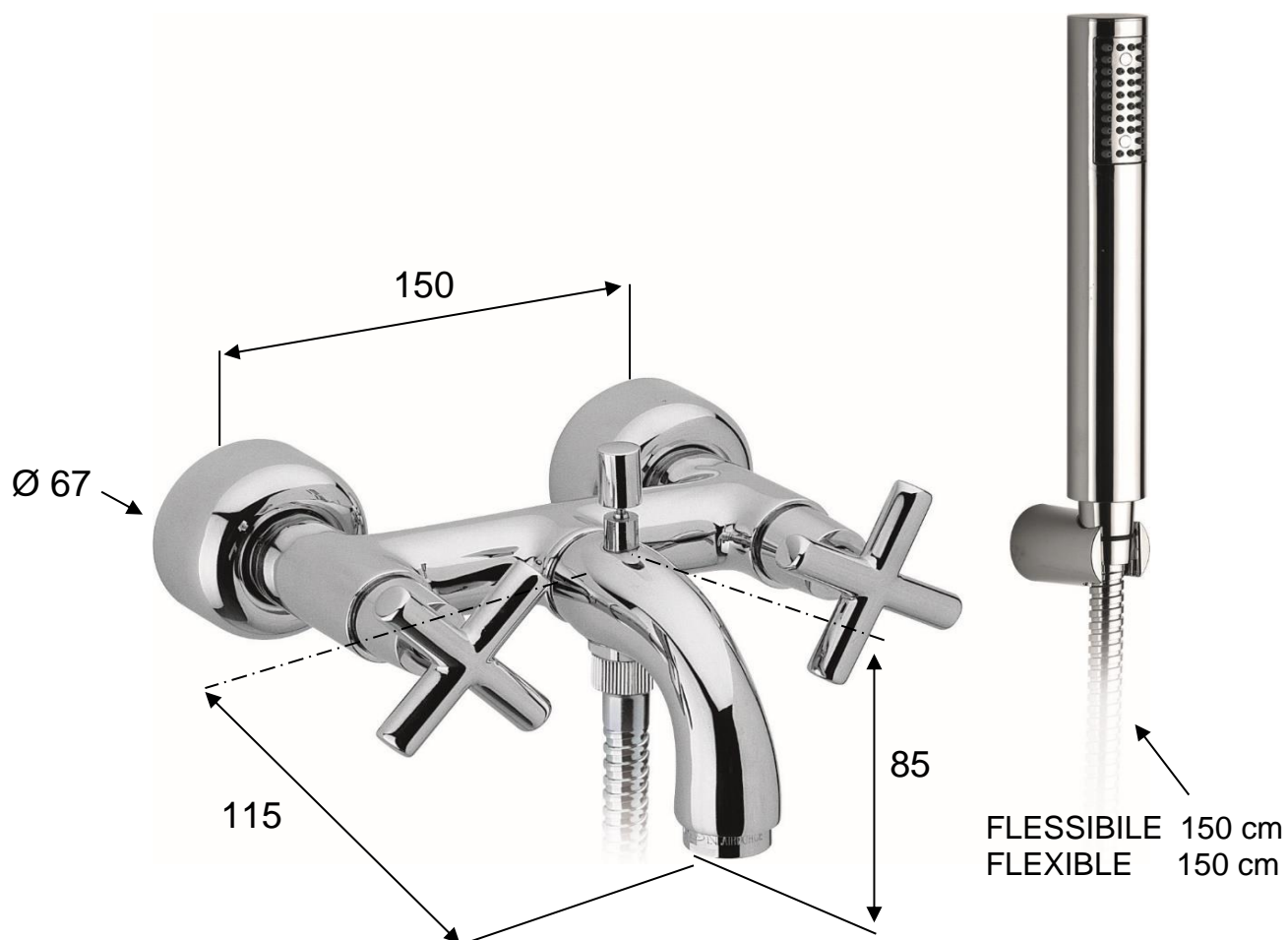

MATERIALI / MATERIALS

OTTONE CROMATO / CHROME PLATED BRASS

CROMATURA / CHROME PLATING

UNI EN 248