

SCHEMA TECNICA TECHNICAL FEATURES

Art. AST4004040

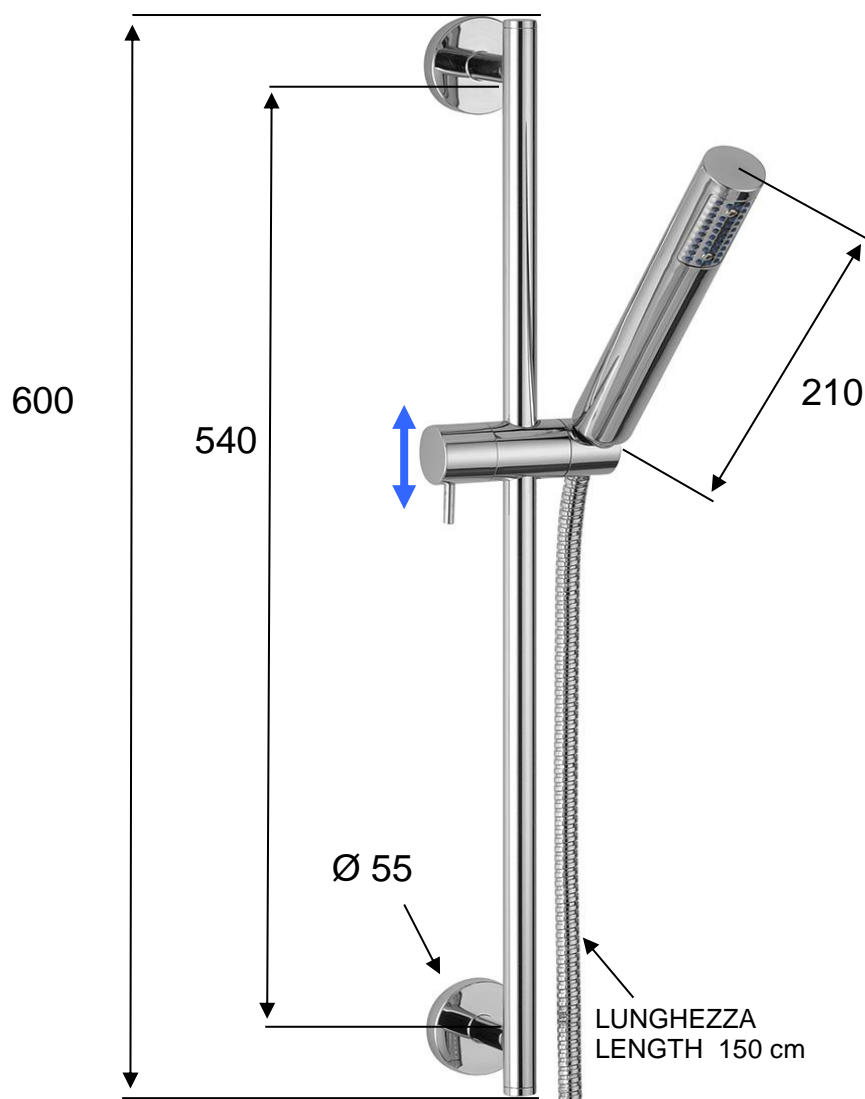

MATERIALI / MATERIALS

OTTONE CROMATO / CHROME PLATED BRASS

ABS CROMATO / CHROME PLATED ABS

CROMATURA / CHROME PLATING

UNI EN 248