

# SCHEDA TECNICA TECHNICAL FEATURES

Art. 106S1004

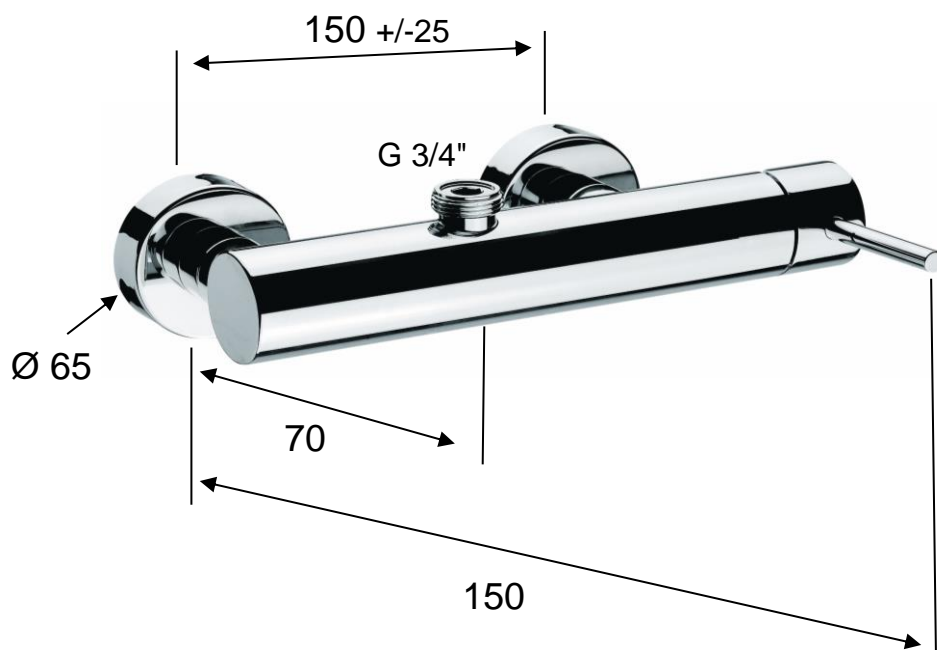

## MATERIALI / MATERIALS

OTTONE CROMATO / CHROME PLATED BRASS

## CROMATURA / CHROME PLATING

UNI EN 248