

SCHEMA TECNICA TECHNICAL FEATURES

Art. 103D1000

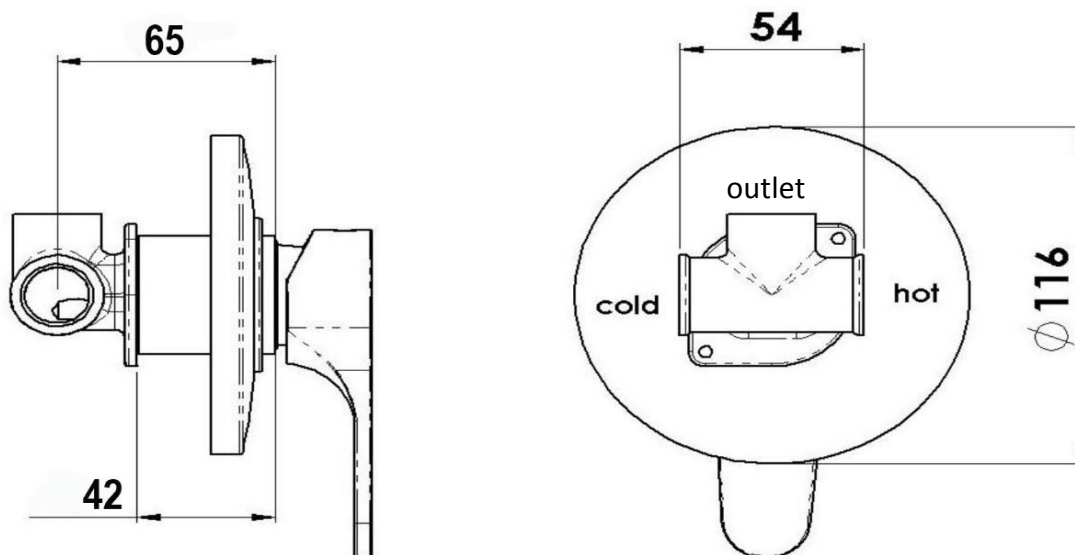

MATERIALI MATERIALS

OTTONE CROMATO CHROME PLATED BRASS

CROMATURA / CHROME PLATING

UNI EN 248